

INSTRUKCJA MONTAŻU 09/2018  
ASSEMBLY INSTRUCTION  
INSTALLATIONSHANDBUCH

GIIS



# Wiaty Shelters Schuppen



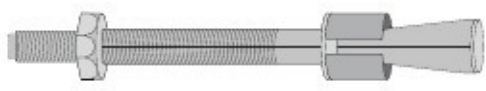
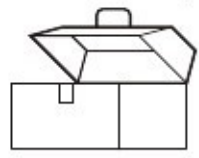
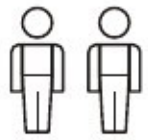
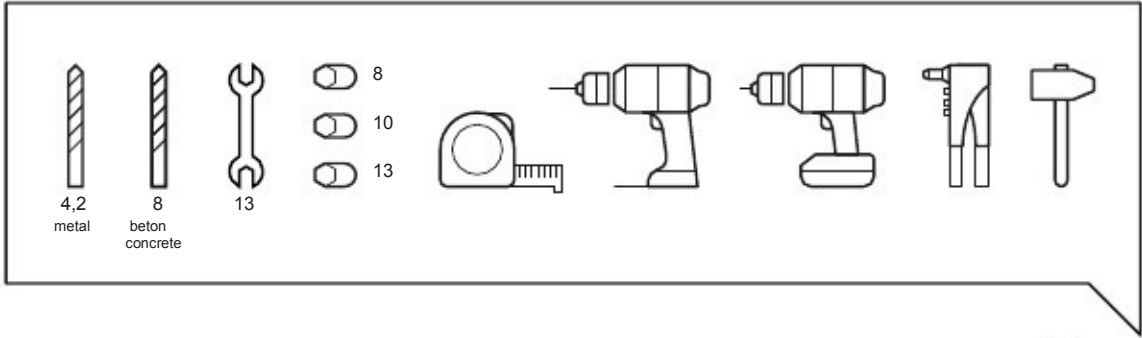

D8\*75 X



M8\*16 X



4,8\*19 X

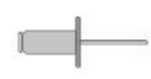

4\*8 X

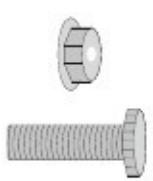

M8\*15,5 X



UPDM 14 X

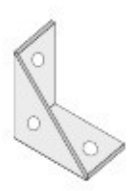

X

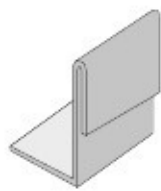

X

T10

Blacha dachowa  
Roof sheet  
Dachplatte

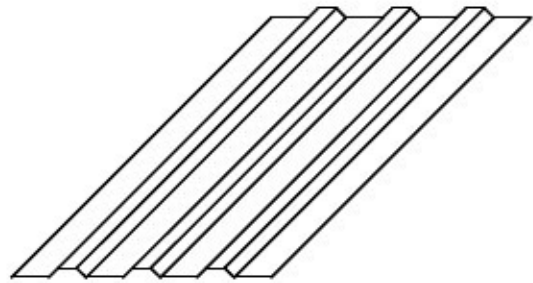

BDL

BDF

BDR

Blenda dachowa  
Roof blende  
Dachmembran

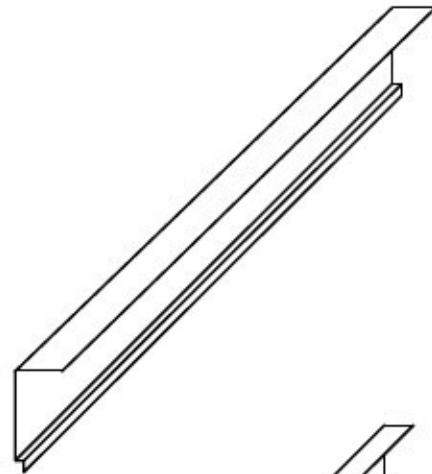

KPF

Kątownik pionowy front  
Front roof bracket  
Front Dachwinkel

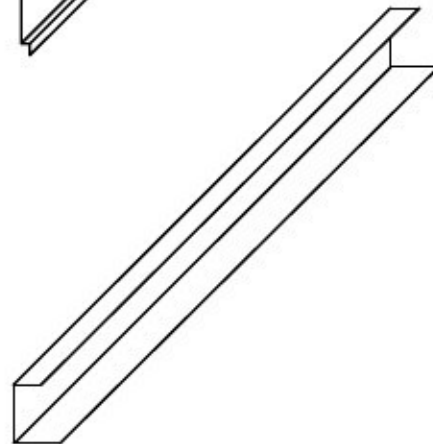

BN

Blenda narożnikowa  
Corner bracket  
Eckwinkel



Z

Belka dachowa (ceownik)  
Roof beam  
Dachbalken

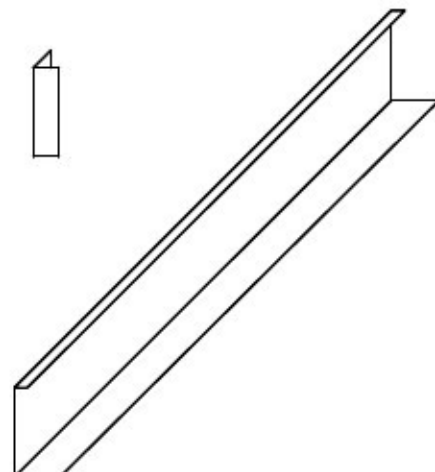





M8\*16 + nakrętka/nut/nuss



D8\*75





M8\*16 + nakrętka/nut/nuss



D8\*75



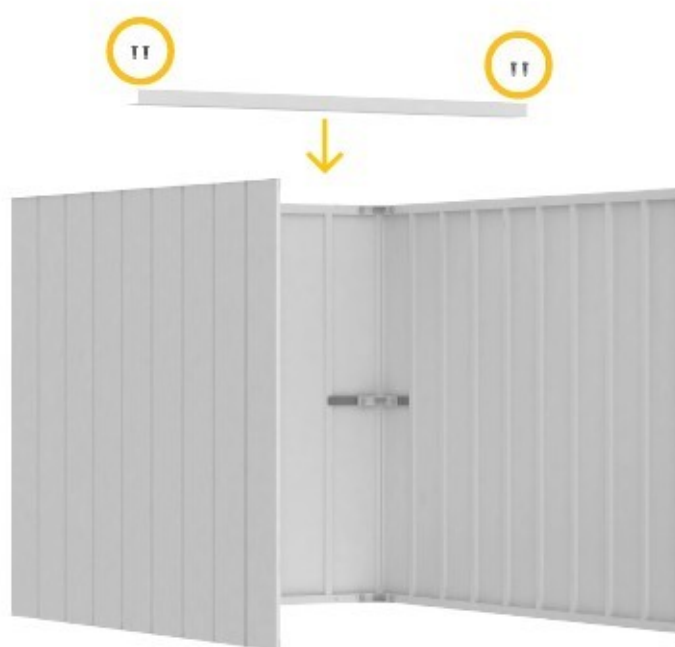

4,8\*19

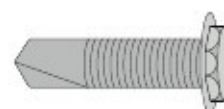



4,8\*19

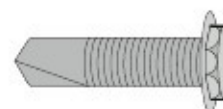





Sprawdzenie przekątnych bez bramy.

Checking diagonals without a gate.

Diagonalen ohne Tor prüfen.

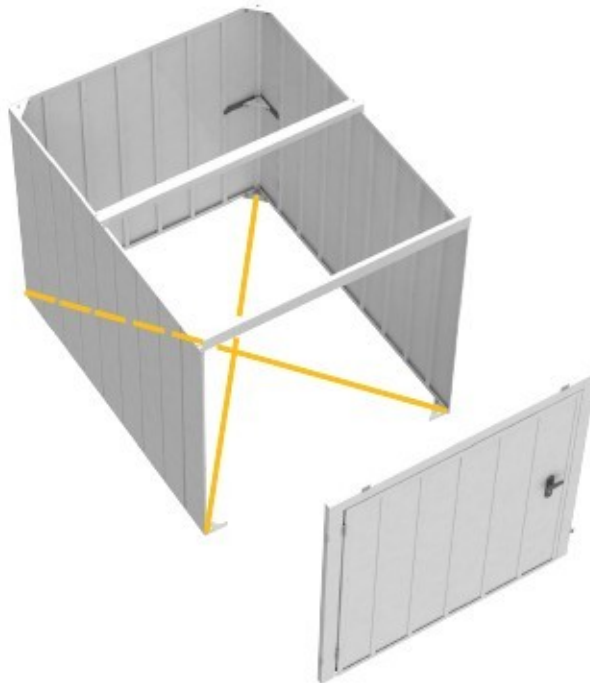

Sprawdzenie przekątnych z bramą.

Checking the diagonals with the gate.

Überprüfen der Diagonalen mit dem Tor.



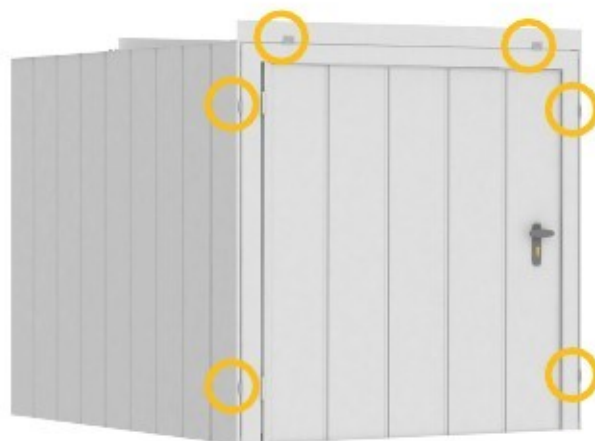

4,8\*19

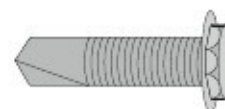



4,8\*19

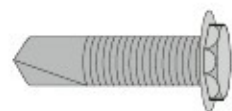



4,8\*19

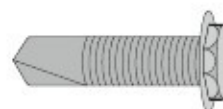

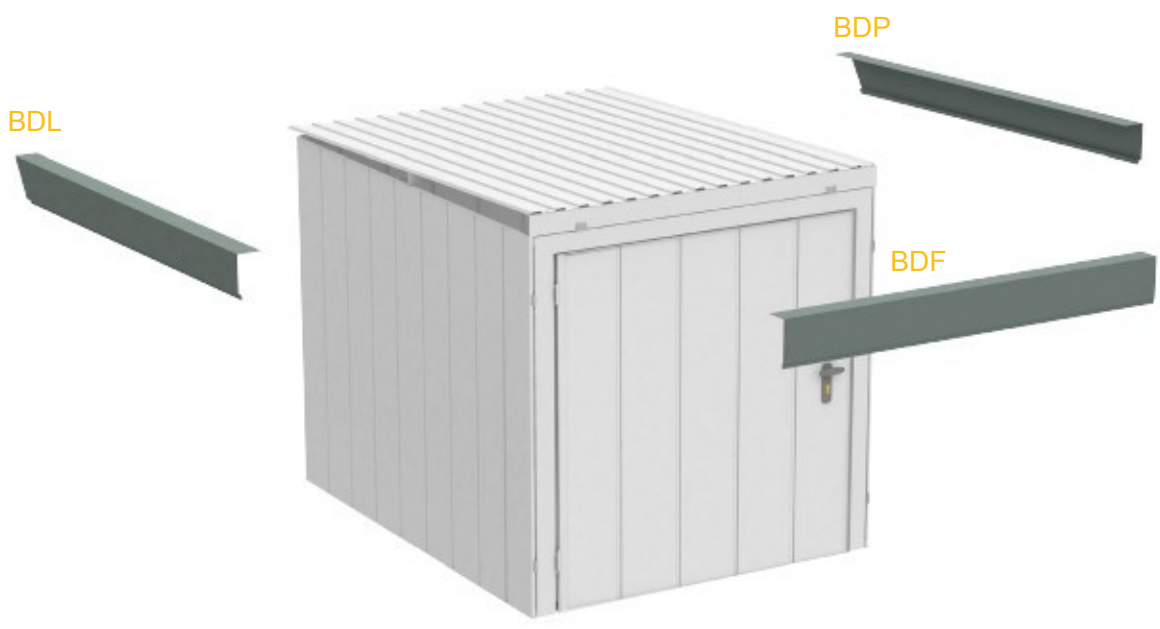

4\*8

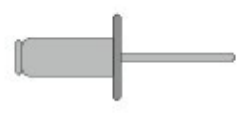



4\*8

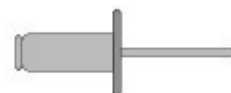



4\*8

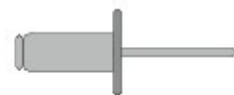



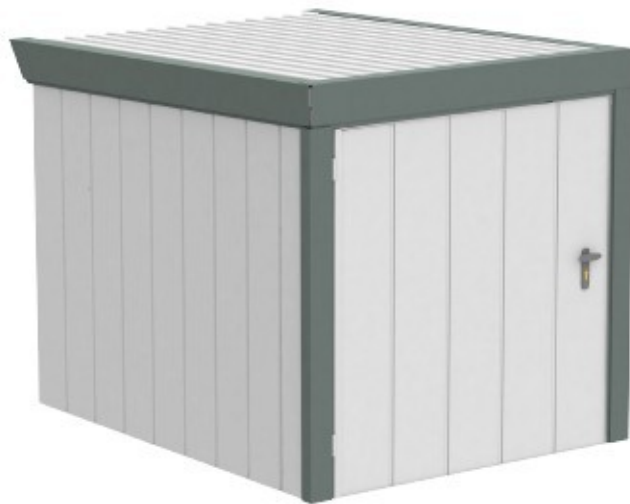

4\*8





4\*8

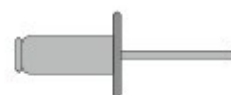

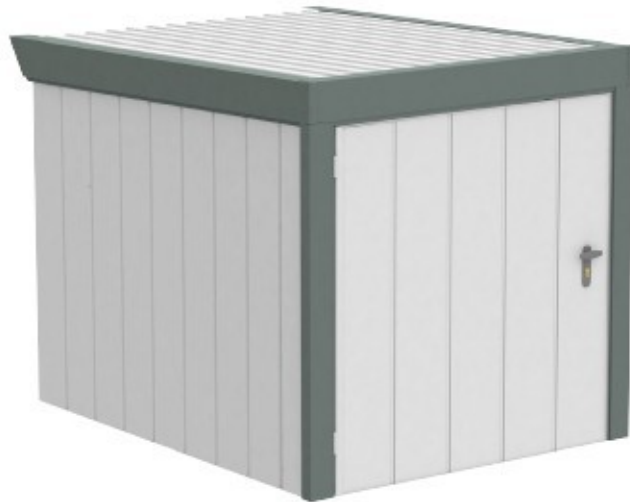

4\*8

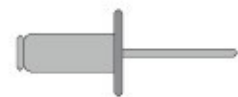



M8\*16 + nakrętka/nut/nuss

D8\*75





