

INSTRUKCJA MONTAŻU 09/2018
ASSEMBLY INSTRUCTION
INSTALLATIONSHANDBUCH

GIIS



Wiaty Shelters Schuppen



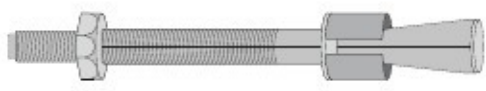
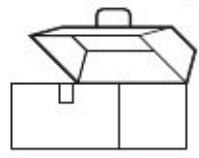
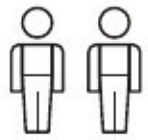
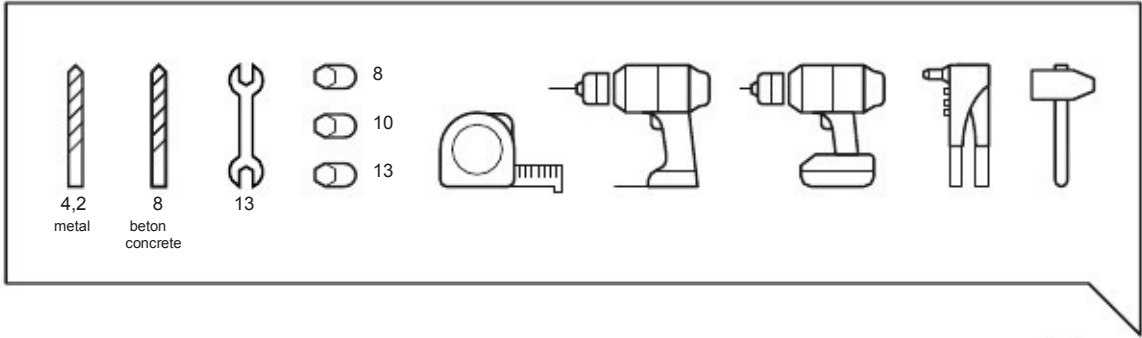

D8*75 X



M8*16 X



4,8*19 X

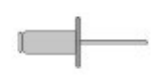

4*8 X

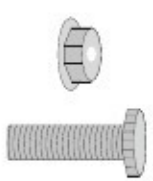

M8*15,5 X



UPDM 14 X

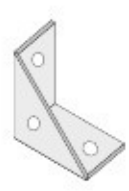

X

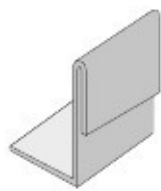

X

T10

Blacha dachowa
Roof sheet
Dachplatte

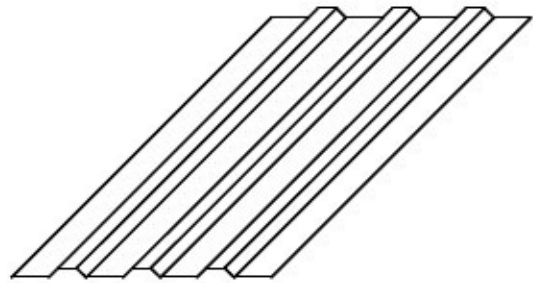

BDL

BDF

BDR

Blenda dachowa
Roof blende
Dachmembran

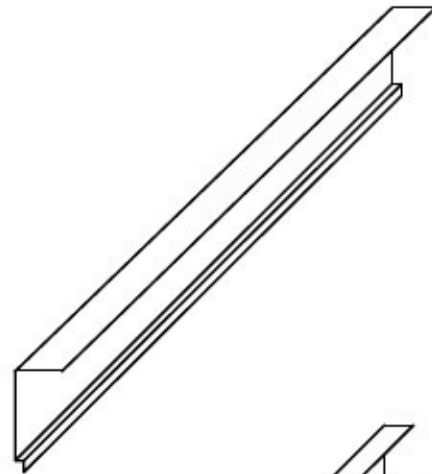

KPF

Kątownik pionowy front
Front roof bracket
Front Dachwinkel

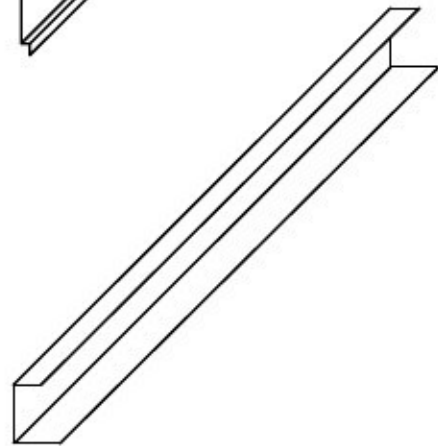

BN

Blenda narożnikowa
Corner bracket
Eckwinkel



Z

Belka dachowa (ceownik)
Roof beam
Dachbalken

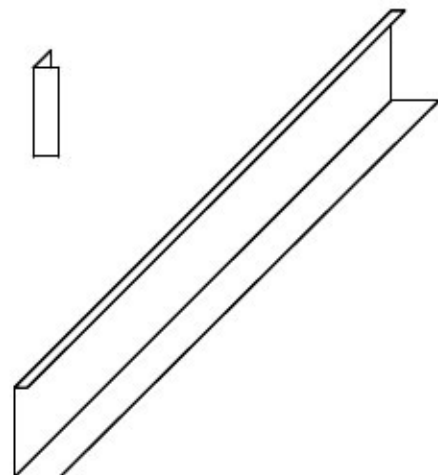





M8*16 + nakrętka/nut/nuss



D8*75





M8*16 + nakrętka/nut/nuss



D8*75



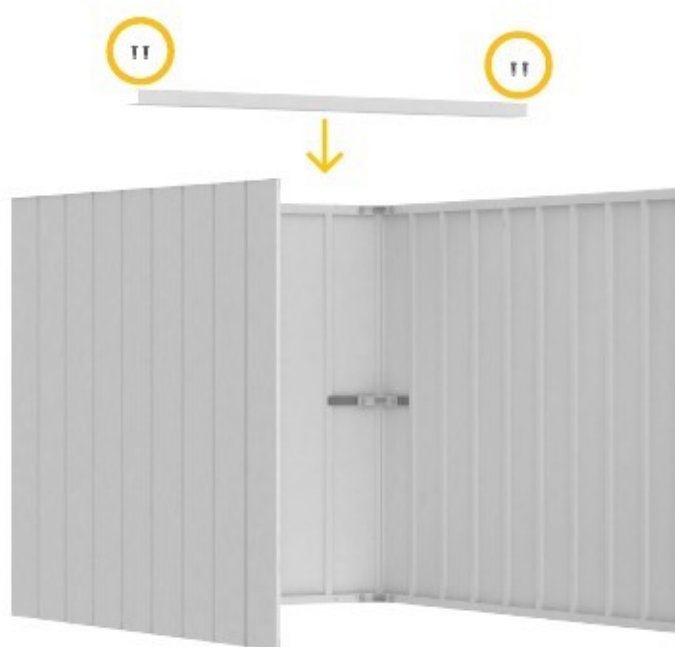

4,8*19

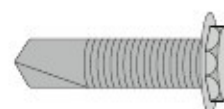



4,8*19

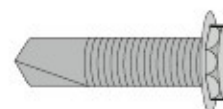



Sprawdzenie przekątnych bez bramy.

Checking diagonals without a gate.

Diagonalen ohne Tor prüfen.

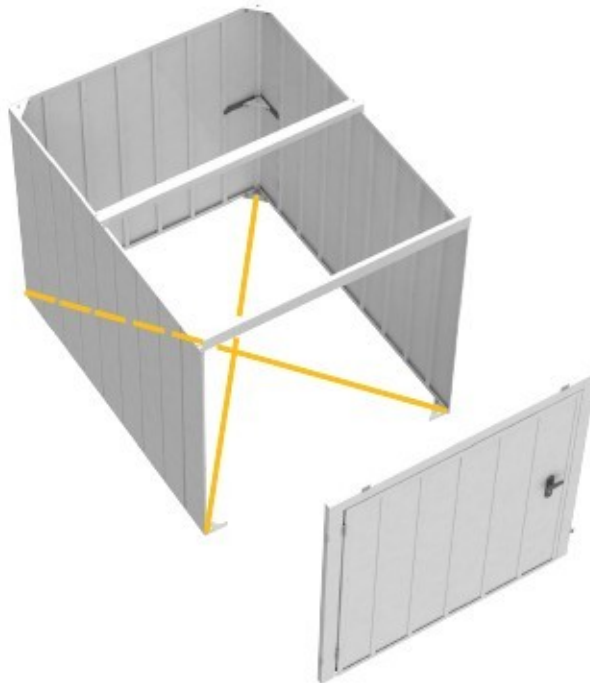

Sprawdzenie przekątnych z bramą.

Checking the diagonals with the gate.

Überprüfen der Diagonalen mit dem Tor.



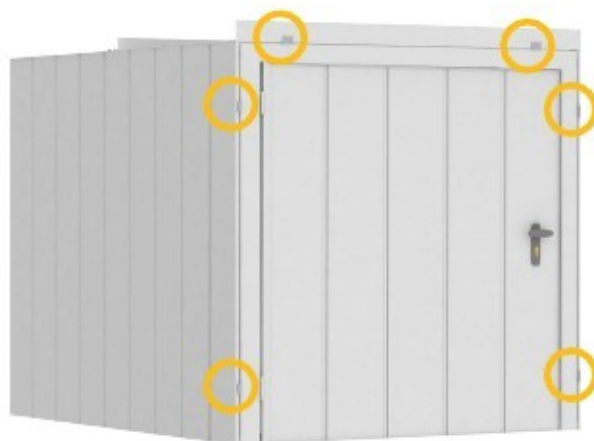

4,8*19

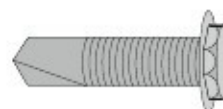



4,8*19

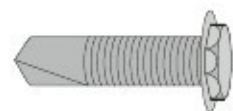



4,8*19

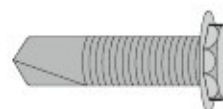

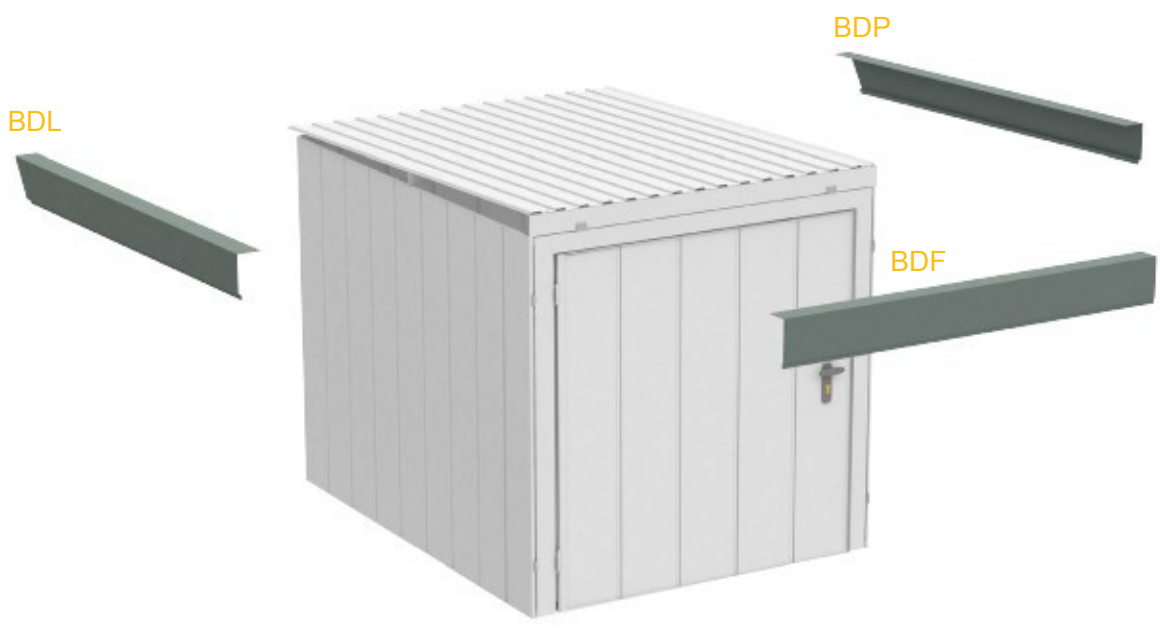

4*8

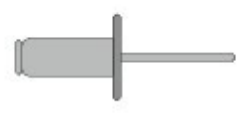



4*8

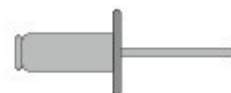



4*8

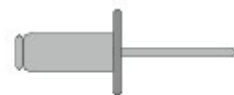

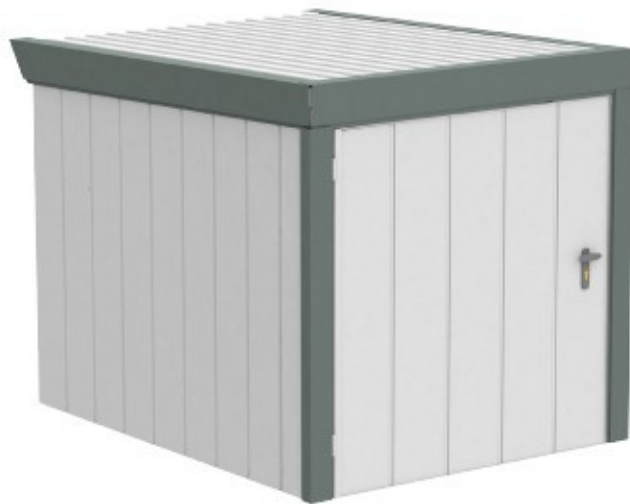

4*8





4*8



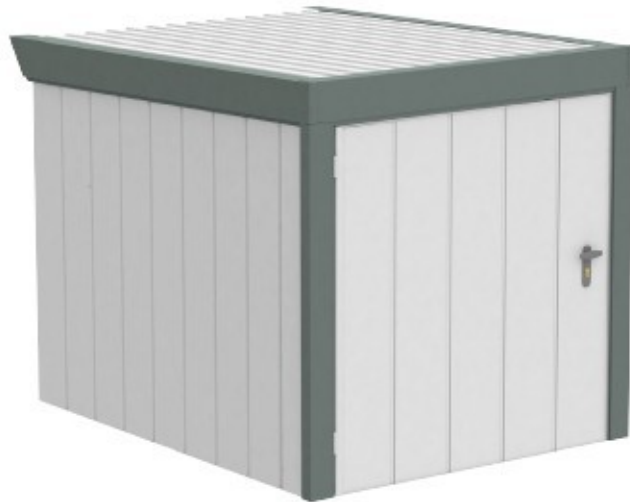

4*8

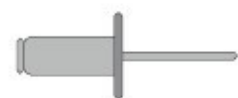



M8*16 + nakrętka/nut/nuss

D8*75



